

V120-22-R6C

Graphic Operator Panel & Programmable Logic Controller

24VDC, 6 pnp/npn digital inputs, 6 analog inputs, 1 high-speed counter/shaft encoder input, 6 relay outputs, I/O expansion port, 2 RS232/RS485 ports, CANbus

Power supply	
Permissible range	24VDC 20.4VDC to 28.8VDC with less than 10% ripple
Maximum current consumption	190mA@24VDC (pnp inputs) 240mA@24VDC (npn inputs)
Digital inputs	
	6 pnp (source) or npn (sink) inputs. See Note 1.
Nominal input voltage	24VDC. See Note 2.
Input voltages for pnp (source):	0-5VDC for Logic '0' 17-28.8VDC for Logic '1'
Input voltages for npn (sink):	17-28.8VDC/<2mA for Logic '0' 0-5VDC/>6mA for Logic '1'
Input current	8mA@24VDC
Input impedance	3KΩ
Response time (except high-speed inputs)	10mS typical
Galvanic isolation	None
Input cable length	Up to 100 meters, unshielded
High-speed counter	
	Specifications below apply when inputs are wired for use as a high-speed counter input/shaft encoder. See Notes 3 and 4.
Resolution	32-bit
Input frequency	10kHz max.
Minimum pulse	40μs

Notes:

- All 6 inputs can be set to pnp (source) or npn (sink) via a single jumper and appropriate wiring.
- npn (sink) inputs use voltage supplied from the controller's power supply.
- Input #0 can function as either high-speed counter or as part of a shaft encoder. In either case, high-speed input specifications apply. When used as a normal digital input, normal input specifications apply.
- Input #1 can function as either counter reset, or as a normal digital input; in either case, specifications are those of a normal digital input. This input may also be used as part of a shaft encoder, in this case, high-speed input specifications apply.

Power supply, pnp (source) inputs

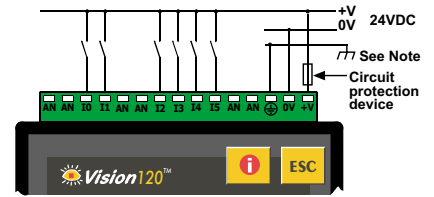

Note:

To avoid electromagnetic interference, mount the controller in a metal panel/cabinet and earth the power supply. Earth the power supply signal to the metal using a wire whose length does not exceed 10cm. If your conditions do not permit this, do not earth the power supply.

npn (sink) inputs

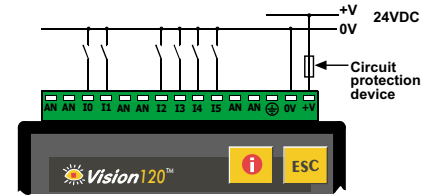

pnp (source) high-speed counter

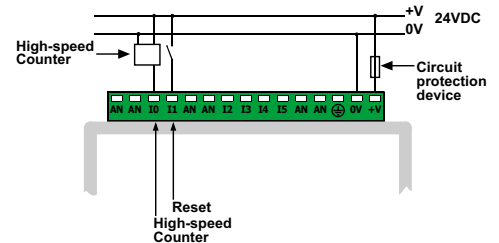

npn (sink) high-speed counter

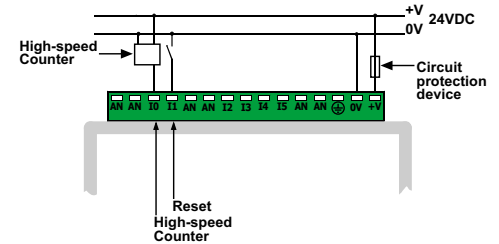

Shaft encoder

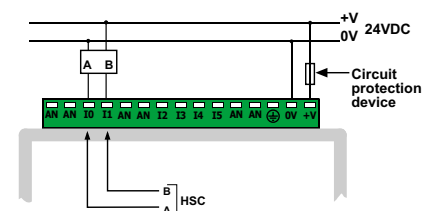

Warnings:

- Unused pins should not be connected. Ignoring this directive may damage the controller.
- Improper use of this product may severely damage the controller.
- Refer to the controller's User Guide regarding wiring considerations.
- Before using this product, it is the responsibility of the user to read the product's User Guide and all accompanying documentation.

Analog Inputs	
Type of Input	
AN0 - AN1	Two 10-bit, multi-range inputs: 0-10V, 0-20mA, 4-20mA
AN2 - AN5	Four 10-bit, current inputs: 0-20mA, 4-20mA. See Note 5
Conversion method	Successive approximation
Input impedance	
AN0 - AN1	>100K Ω for voltage 500 Ω for current
AN2 - AN5	243 Ω for current
Galvanic isolation	None
Resolution (except 4-20mA)	10-bit (1024 units)
Resolution at 4-20mA	204 to 1023 (820 units)
Conversion time	According to filter
Absolute max. rating	$\pm 15V$
Full scale error	± 2 LSB
Linearity error	± 2 LSB
Status indication	Yes, See Note 6.

Notes:

- Analog inputs AN2 -AN5 can function only as current inputs.
- The analog value can also indicate when the input is functioning out of range. If an analog input deviates above the permissible range, its value will be 1024.

Voltage / Current connection

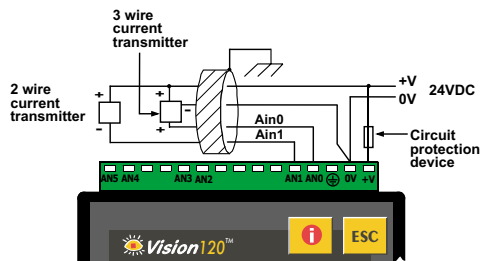
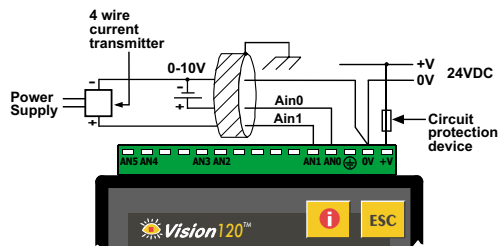

- Note:
- Shields should be connected at the signals' source.
The 0V signal of the analog input must be connected to the controller's 0V.

Digital outputs	
Output type	6 relay outputs, 230VAC / 24VDC
Type of relay	SPST-NO relay Takamisawa JY-24H-K, or NAIS (Matsushita) JQ1A-24V or OMRON G6B-1114P-24VDC
Isolation	by relay
Output current	5A max. (resistive load) 1A max. (inductive load)
Max. frequency	0.5Hz (at maximum rated load)
Contact protection	External precautions required

Relay Outputs

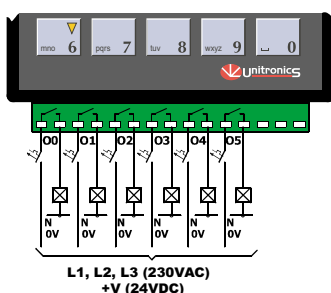

Graphic Display	
Illumination backlight	LED, yellow-green, software-controlled
Display resolution	128x64 pixels
Keypad	
Number of keys	16
Program	
Application Memory	448K
Memory Bits (coils)	2048
Memory Integers (registers)	1600
Long Integers (32 bit)	256
Double Word (32 bit unsigned)	64
Floats	24
Timers	192
Counters	24
Data Tables	120K (RAM) / 64K (FLASH)
HMI displays	Up to 255
Execution time	0.8 μ s for bit operations

RS232/RS485 serial ports	
Used for:	<ul style="list-style-type: none"> Application Download/Upload Application Testing (Debug) Connect to GSM or standard telephone modem: <ul style="list-style-type: none"> Send/receive SMS messages Remote access programming RS485 Networking
RS232 (See Note 8)	2 ports
Galvanic isolation	None
Voltage limits	$\pm 20V$
RS485 (See Note 8)	2 ports
Input voltage	-7 to +12V differential max.
Cable type	Shielded twisted pair, in compliance with EIA RS485
Galvanic isolation	None
Baud rate	110 – 57600 bps
Nodes	Up to 32

Note:

- RS232/RS485 is determined by jumper settings and wiring.
Refer to the controller's User Guide regarding communications.

I/O expansion port	
	Up to 128 additional I/Os, including digital & analog I/Os, RTD and more.
CANbus port	
	Up to 63 nodes
Baud rate range	20Kbps - 1Mbps
Cable length	Up to 1000m for 24VDC network

CANbus connection

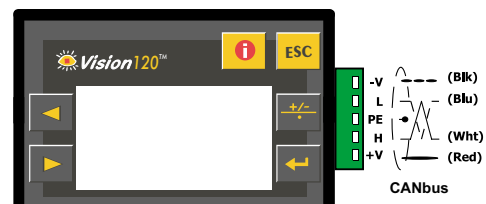

Miscellaneous	
Clock (RTC)	Real-time clock functions (Date and Time).
Battery back-up	7 years typical battery back-up for RTC and system data.
Battery	Coin type, 3V lithium battery, CR2450
Weight	320g (11.3 oz)
Operational temperature	0 to 50°C (32 to 122°F)
Storage temperature	-20 to 60°C (-4 to 140°F)
Relative Humidity (RH)	5% to 95% (non-condensing)
Mounting method	DIN-rail mounted (IP20/NEMA1) Panel mounted (IP65/NEMA4X)

V120-22-R6C

I/O Jumper Settings

The tables below show how to set a specific jumper to change the functionality of the controller. To open the controller and access the jumpers, refer to the directions at the end of these specifications.

Important:

Incompatible jumper settings and wiring connections may severely damage the controller.

Digital Inputs type

	npn (sink)	pnp (source)*
JP1	A	B

Note:

Jumper #2 is not used.

Analog Inputs type

	Voltage	Current*
JP3	A	B
JP4	A	B

*Default factory settings.

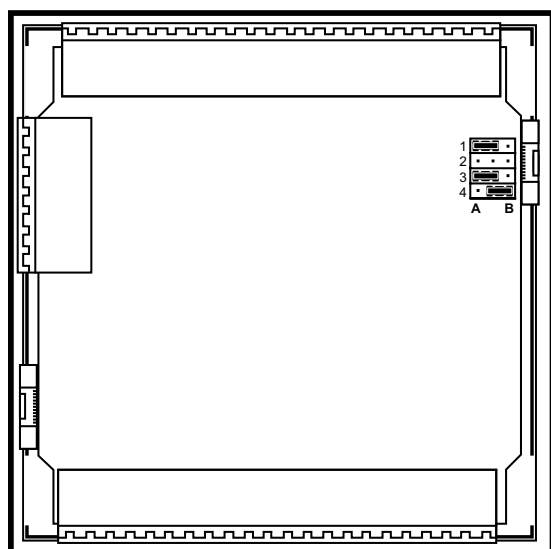

In this figure, the jumper settings will cause the controller to function as follows:

Digital inputs: npn

Analog input #0: Voltage input

Analog input #1: Current input

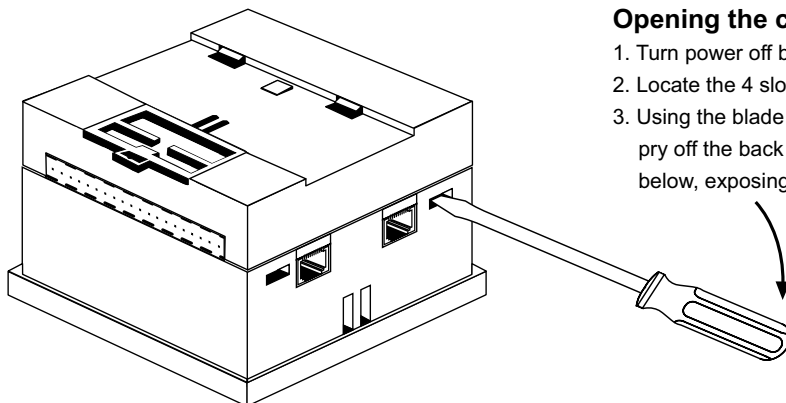

Opening the controller's enclosure

1. Turn power off before opening the controller.
2. Locate the 4 slots on the sides of the enclosure.
3. Using the blade of a flat-bladed screwdriver, gently pry off the back of the controller as shown in the figure below, exposing the controller's board.

Unitronics reserves the right to revise this publication from time to time and to amend its contents and related hardware and software at any time.

Technical updates (if any) may be included in subsequent editions (if any).

Unitronics product sold hereunder can be used with certain products of other manufacturers at the user's sole responsibility.